

Print Bohrplan Bestückungsseite
PCB-Layout (component side)

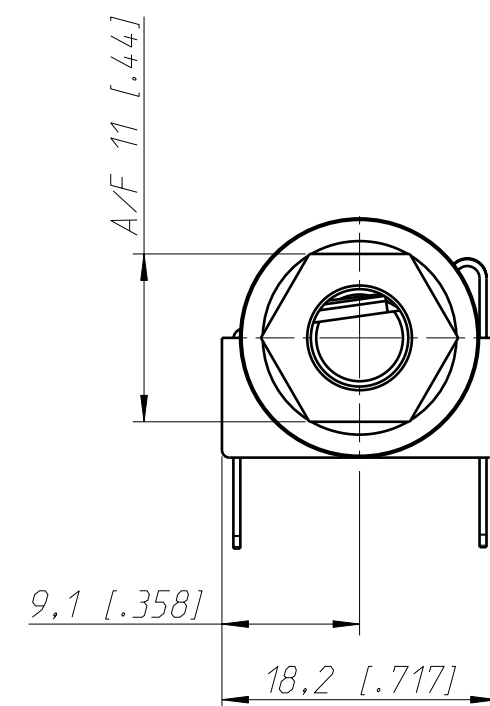

Frontplattenausschnitt (Rückseite)
Panel cut out (rear side)

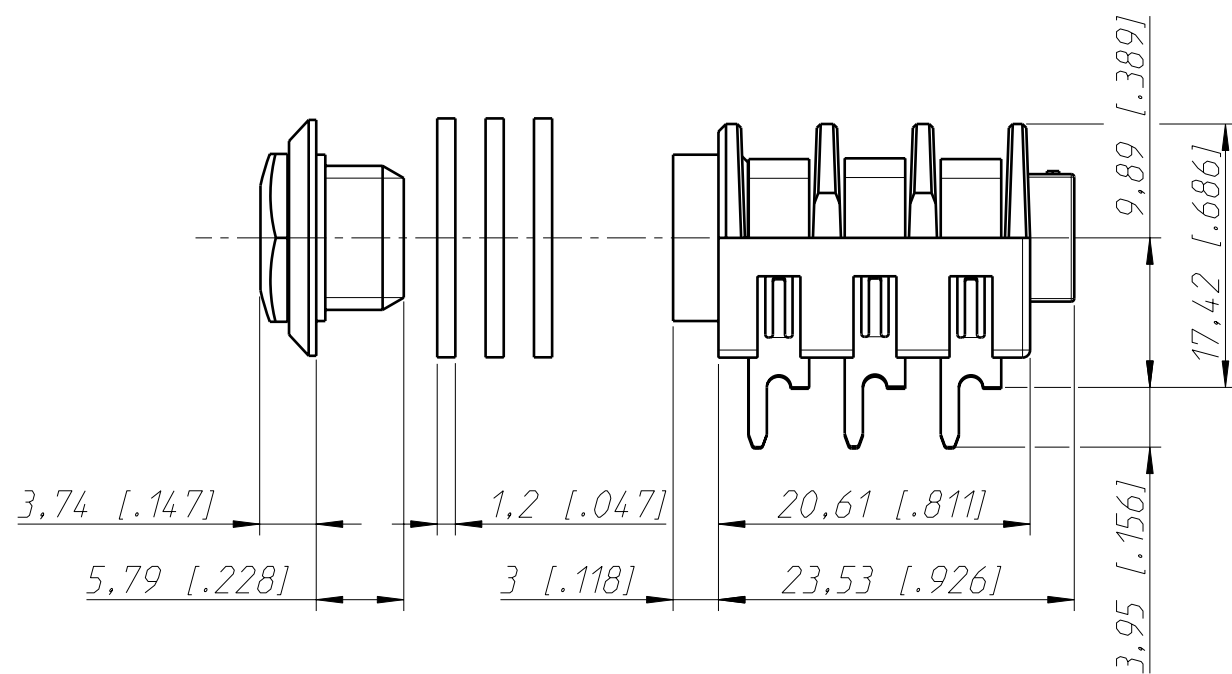
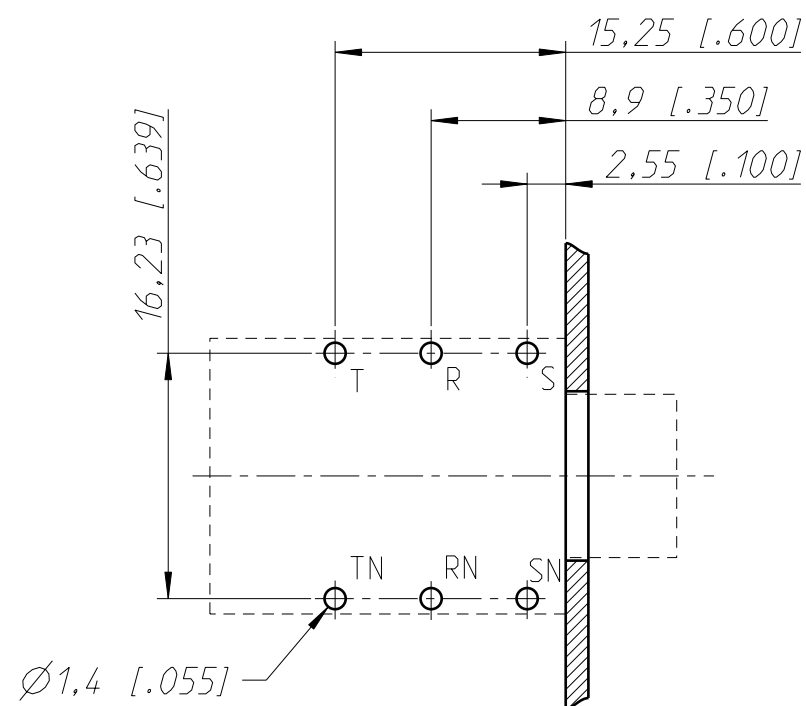
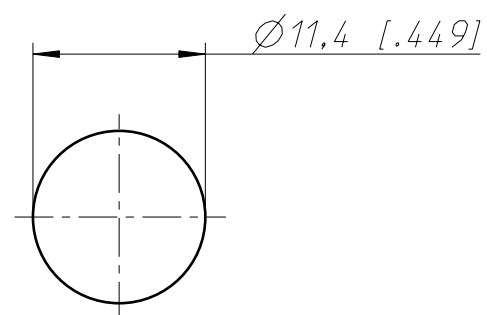

Sheet Number 1/1	Projection 	Scale 2:1	Format A3	Tolerancing ISO 2768-mK	
ECN Number -		Created 20.02.2003	noe		
Description NMJ6HCD3			Modified 26.02.2021	mmu	
			Approved 26.02.2021	phk	
			Status Released		
NEUTRIK		3D Model ID NMJ6HCD3	Document ID ST-NMJ6HCD3	Revision -	